



## MP6000/MP7000 Technical Accessory Guide



NOTE: MP6000 discontinued 1/2018 - see PMB 3036

NOTE: This document is only for general reference. Solutions Pathway and related PMBs should be used for product availability, pricing, and final solution selection.

\* Zebra does not endorse or specifically recommend any **third-party products, accessories, or hardware**. ZEBRA DISCLAIMS ANY AND ALL LIABILITY, INCLUDING ANY EXPRESS OR IMPLIED WARRANTIES, WHETHER ORAL OR WRITTEN, FOR SUCH THIRD PARTY PRODUCTS, ACCESSORIES, OR HARDWARE. THE CUSTOMER ACKNOWLEDGES THAT NO REPRESENTATION HAS BEEN MADE BY ZEBRA AS TO THE FITNESS OF THE THIRD-PARTY PRODUCTS, ACCESSORIES, OR HARDWARE FOR THE CUSTOMER'S INTENDED PURPOSE.

### Communication Cables

Zebra associates and partners can also see Zebra's Universal Cable Guide at:

[https://partnerportal.zebra.com/PartnerPortal/product\\_services/downloads\\_z/barcode\\_scanners/Universal-Cable-Guide-Bar-Code-Scanners.xlsx](https://partnerportal.zebra.com/PartnerPortal/product_services/downloads_z/barcode_scanners/Universal-Cable-Guide-Bar-Code-Scanners.xlsx)



#### Standard USB Cables

Part Number	Picture	Description	Notes	Required Items
CBA-U51-S16ZAR		USB Cable: Series A Connector, 5 meter Straight		<ul style="list-style-type: none"> <li>▶ Power Supply (PWR-BGA12V50W0WW)</li> <li>▶ DC Line Cord (CBL-DC-388A1-01 for MP7000 or CBL-DC-375A1-01 for MP6000)</li> <li>▶ AC Line Cord (23844-00-00R)</li> </ul>

#### IBM POS USB Cables

Part Number	Picture	Description	Notes	Required Items
CBA-U52-S16PAR		USB Cable: Power Plus Connector, 5 meter Straight	Power is provided from POS	

#### RS232 Cables

Part Number	Picture	Description	Notes	Required Items
CBA-R51-S16ZAR		RS232 Cable:STD-DB9 Female, TxD on 2, 5 meter Straight	Also used to connect scale to POS (Dual Cable Scanner/Scale)	<ul style="list-style-type: none"> <li>▶ Power Supply (PWR-BGA12V50W0WW)</li> <li>▶ DC Line Cord (CBL-DC-388A1-01 for MP7000 or CBL-DC-375A1-01 for MP6000)</li> <li>▶ AC Line Cord (23844-00-00R) to power MP6000/MP7000</li> </ul>
CBA-R52-S16ZAR		RS232 Cable:STD-DB9 Male, TxD on 2, 5 meter Straight	Also used to connect scale to POS (Dual Cable Scanner/Scale)	<ul style="list-style-type: none"> <li>▶ Power Supply (PWR-BGA12V50W0WW)</li> <li>▶ DC Line Cord (CBL-DC-388A1-01 for MP7000 or CBL-DC-375A1-01 for MP6000)</li> <li>▶ AC Line Cord (23844-00-00R) to power MP6000/MP7000</li> </ul>



#### Other POS Terminal RS232 Cables

Part Number	Picture	Description	Notes	Required Items
CBA-R53-S16PAR		RS232 Cable: DB15 TxD on 4, Power on 1, 5 meter Straight	Provides power to MP6000/MP7000	

#### IBM 468x/469x POS Cables

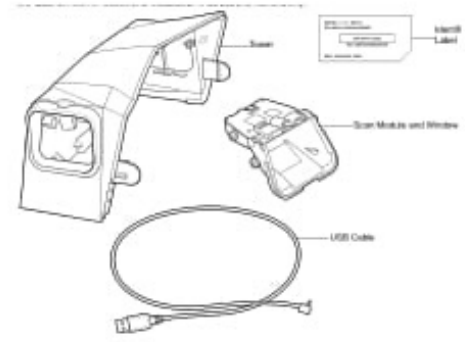

Part Number	Picture	Description	Notes	Required Items
CBA-M51-S16PAR		IBM 468x/9x, Port 9B Cable, 5 meter Straight	<ul style="list-style-type: none"> <li>▶ RS485 interface cable</li> <li>▶ Provides power to MP6000/MP7000</li> </ul>	

#### Auxillary Cables

CBA-A51-S16ZAR		Auxillary Scanner Cable, RS232 Serial	<ul style="list-style-type: none"> <li>▶ Allows handheld scanners (i.e. LI4278, LS4278, or DS6878) to be used with MP6000/MP7000 for scanning heavy/awkward items.</li> <li>▶ 5 meter length</li> <li>▶ RS232 serial connection to scanner</li> <li>▶ Connects to AUX2 port on MP6000/MP7000</li> <li>▶ Provides power to corded scanners</li> <li>▶ NOTE: MP6000/MP7000 supports maximum of 2 auxillary scanners.</li> </ul>	NOTE: If cradle is used with a cordless scanner, it must be powered using an external power supply.
Various		Auxillary Scanner Cable, USB	<ul style="list-style-type: none"> <li>▶ Refer to accessory document for handheld scanner for USB cable choice.</li> <li>▶ Allows handheld scanners (i.e. LI4278, LS4278, or DS6878) to be used with MP6000/MP7000 for scanning heavy/awkward items.</li> <li>▶ USB connection to scanner</li> <li>▶ Connects to AUX A-B port on MP6000</li> <li>▶ Provides 5V power to scanners</li> <li>▶ NOTE: MP6000/MP7000 supports maximum of 2 auxillary scanners.</li> </ul>	
Keyboard Wedge Cables (Not supported by MP6000/MP7000)				
Wand Cables (Not supported by MP6000/MP7000)				
Synapse Adapter Cables (Not supported by MP6000/MP7000)				
<b>Upgrade Kits</b>				
Part Number	Picture	Description	Notes	Required Items
MXC7000-L (camera mounting in Landscape mode)  MXC7000-P (camera mounting in Portrait mode)		MP7000 Camera Upgrade Kit	<ul style="list-style-type: none"> <li>▶ Kit allows color camera option to be added to MP7000 devices in the field.</li> <li>▶ Only compatible with MP7000 units manufactured after 4/1/2020.</li> <li>▶ Kit includes color camera, camera mount for portrait or landscape positioning (SKU dependent), illumination board, 3 meter USB cable and modified MP7000 top housing.</li> <li>▶ Not compatible with Customer Side Scanner (CSS).</li> </ul>	
MX101-SR7000WW		Customer Side Scanner (CSS) for MP7000	<ul style="list-style-type: none"> <li>▶ Allows customers to simultaneously scan their own loyalty cards, coupons, impulse buy items and bar codes displayed on their mobile phones</li> <li>▶ Uses SE3317 scan engine</li> <li>▶ Includes Top Cover, scan engine, and USB cable. Connect USB cable to top port on MP7000 AUX A-B USB ports.</li> <li>▶ Only compatible with MP7000.</li> <li>▶ Not compatible with Color Camera option.</li> </ul>	
<b>Scale Displays</b>				
Part Number	Picture	Description	Notes	Required Items





**Zapraszamy do kontaktu!**  
**Więcej informacji: [www.kreski.pl](http://www.kreski.pl)**

<p>MX201-SI00WW</p>		<p>Scale Display with Pole (Single display) - Pounds or KG - <u>Single</u> Interval</p>	<ul style="list-style-type: none"> <li>▶ Single Display Head: Clear, easy to adjust weight display.</li> <li>▶ Includes scale display templates/overlays for single interval LB, and single interval KG.</li> <li>▶ Single Interval is the most common scale display requirement (used in US) and is used with Single Interval scale configurations of the MP series. Dual Interval (MX201-DI00WW) may be required in other countries (i.e. Russia).</li> <li>▶ Display connects to 0.0 port on MP6000/MP7000.</li> <li>▶ Has a slightly smaller footprint than MX201-SR00004ZZWR/MX201-SR00004ZZRR which allows for easier installation.</li> </ul>	
<p>MX201-DI00WW</p>		<p>Scale Display with Pole (Single display) - Pounds or KG - <u>Dual</u> Interval</p>	<ul style="list-style-type: none"> <li>▶ Single Display Head: Clear, easy to adjust weight display.</li> <li>▶ Includes scale display templates/overlays for dual interval LB and dual interval KG.</li> <li>▶ Dual Interval is not a common display configuration. It may only be required in certain countries (i.e. Russia) and is used with Dual Interval scale configurations of the MP series.. Use Single Interval configuration (MX201-SI00WW) in most countries (including US).</li> <li>▶ Display connects to 0.0 port on MP6000/MP7000.</li> <li>▶ Has a slightly smaller footprint than MX201-SR00004ZZWR/MX201-SR00004ZZRR which allows for easier installation.</li> </ul>	
<p>MX202-SI00WW</p>		<p>Scale Display with Pole (Dual display) - Pounds or KG - <u>Single</u> Interval</p>	<ul style="list-style-type: none"> <li>▶ Dual Display Heads: Clear, easy to adjust weight display.</li> <li>▶ Dual-heads are used where the law is strictest on visibility of the weight value for cashier and customer. Design fully rotates both heads independently, offering maximum flexibility and visibility. Competing designs have heads whose rotation interferes with each other, limiting the choice for direction of display.</li> <li>▶ Includes scale display templates/overlays for single interval LB, and single interval KG.</li> <li>▶ Single Interval is the most common scale display requirement (used in US) and is used with Single Interval scale configurations of the MP series. Dual Interval (MX202-DI00WW) may be required in other countries (i.e. Russia).</li> <li>▶ Display connects to 0.0 port on MP6000/MP7000.</li> </ul>	

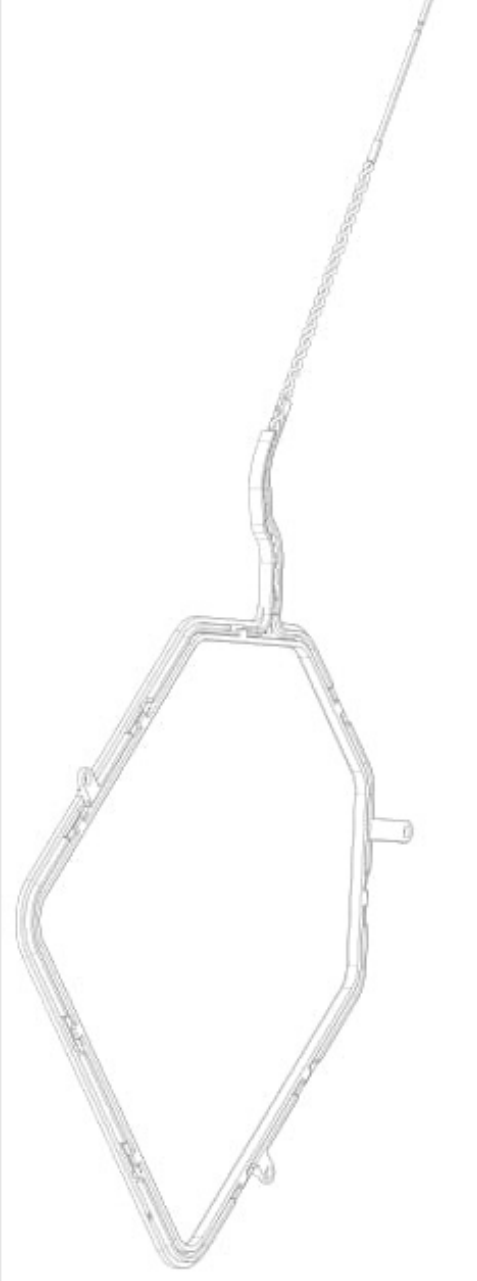

**Zapraszamy do kontaktu!**  
**Więcej informacji: [www.kreski.pl](http://www.kreski.pl)**

<p>MX202-DI00WW</p>		<p>Scale Display with Pole (Dual display) - Pounds or KG - Dual Interval</p>	<ul style="list-style-type: none"> <li>▶ Dual Display Heads: Clear, easy to adjust weight display.</li> <li>▶ Dual-heads are used where the law is strictest on visibility of the weight value for cashier and customer. Design fully rotates both heads independently, offering maximum flexibility and visibility. Competing designs have heads whose rotation interferes with each other, limiting the choice for direction of display.</li> <li>▶ Includes scale display templates/overlays for dual interval LB, and dual interval KG.</li> <li>▶ Dual Interval is not a common display configuration. It may only be required in certain countries (i.e. Russia) and is used with Dual Interval scale configurations of the MP series. Use Single Interval configuration (MX202-SI00WW) in most countries (including US).</li> <li>▶ Display connects to 0.0 port on MP6000/MP7000.</li> </ul>	
<p>MX201-POLE-EXT</p>		<p>Scale Display Extension Pole</p>	<ul style="list-style-type: none"> <li>▶ Compatible with Scale Display with Pole (Single display) - (MX201-SI00WW)</li> <li>▶ Extends length of scale display pole by 24 inches.</li> <li>▶ Includes pipe flange for mounting pole on countertop and 4 screws</li> </ul>	
<p><b>Misc</b></p>				
Part Number	Picture	Description	Notes	Required Items
<p>CBA-A54-S01EAR</p>		<p>Checkpoint Interlock Cable</p>	<ul style="list-style-type: none"> <li>▶ Allows MP6000/MP7000 to send good barcode scan message to Checkpoint system for EAS tag deactivation in parallel to scanning the barcode on the product</li> <li>▶ Cable connects to Checkpoint Interlock Port on MP6000/MP7000.</li> <li>▶ Requires proper integration with Checkpoint EAS system by Checkpoint personnel.</li> </ul>	
<p>MX306-SA00WW</p>		<p>Checkpoint Antenna - Horizontal</p>	<ul style="list-style-type: none"> <li>▶ Antenna used to de-activate Checkpoint Electronic Article Surveillance (EAS) Systems.</li> <li>▶ Only compatible with MP7000.</li> </ul>	

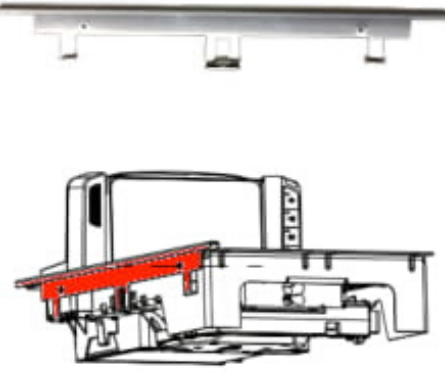
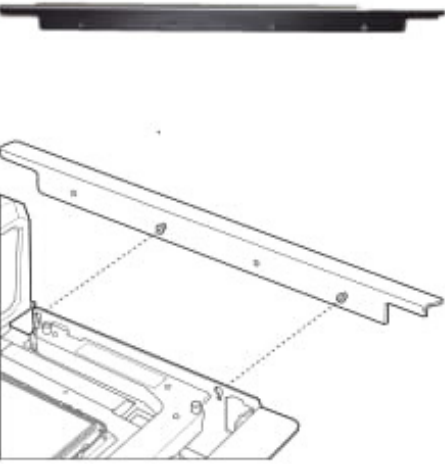
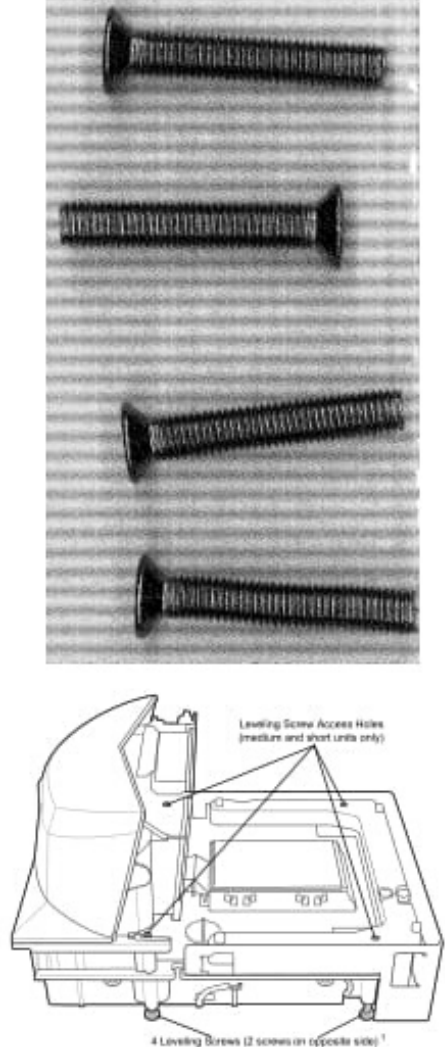

MX307-SA00WW		Checkpoint Antenna - Vertical	<ul style="list-style-type: none"> <li>▶ Antenna used to de-activate Checkpoint Electronic Article Surveillance (EAS) Systems.</li> <li>▶ Only compatible with MP7000.</li> </ul>	
MX303-RAIL		Width Extender (trim piece) for MP7000	<ul style="list-style-type: none"> <li>▶ Used with M7000 Long models to fit into a counter cut-out previously occupied by a 12 in. wide NCR scanner/scale.</li> <li>▶ The trim can be mounted on either side of the MP7000. Recommendation is to install on the downstream side of the conveying goods.</li> <li>▶ Adds 0.5 in. (1.2 cm) to the width of the MP7000.</li> <li>▶ Improved design vs. MX303-SB-05 which is easier to install.</li> </ul>	
MX303-SB-05		Width Extender (trim piece) for MP7000	<ul style="list-style-type: none"> <li>▶ To be discontinued, now use MX303-RAIL.</li> <li>▶ Used with M7000 Long models to fit into a counter cut-out previously occupied by a 12 in. wide NCR scanner/scale.</li> <li>▶ The trim can be mounted on either side of the MP7000. It should be installed in the downstream side of the conveying goods.</li> <li>▶ Adds 0.5 in. (1.2 cm) to the width of the MP7000.</li> <li>▶ Includes 4 screws for attaching Extender</li> <li>▶ Recommend using MX303-RAIL instead. This extender is easier to install.</li> </ul>	
MX301-SR00004ZZWR		Leveling Screws - Standard length, pack of 4	<ul style="list-style-type: none"> <li>▶ NOTE: These screws are already included with each Short or Medium size MP7000 unit.</li> <li>▶ Used with Short and Medium size MP6000/MP7000 units.</li> <li>▶ Long versions do not support leveling screws. The checkstand should provide for two leveling screws under the front and rear of the MP6000/MP7000.</li> <li>▶ M8 x 50 mm size</li> <li>▶ Allows fine adjustment of short and medium model MP6000/MP7000 scanners so they are perfectly flush in the checkstand</li> </ul>	

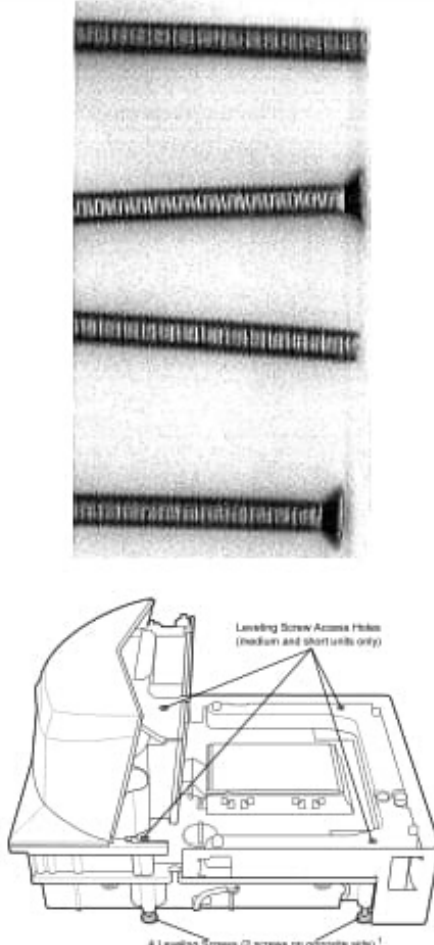

**Zapraszamy do kontaktu!**  
**Więcej informacji: [www.kreski.pl](http://www.kreski.pl)**

MX302-SR00004ZZWR		Leveling Screws - Extended length, pack of 4	<ul style="list-style-type: none"> <li>▶ M8 x 70 mm size</li> <li>▶ Used with Short and Medium size MP6000/MP7000 units.</li> <li>▶ Long versions do not support leveling screws. The checkstand should provide for two leveling screws under the front and rear of the MP6000/MP7000.</li> <li>▶ The MP6000/MP7000 is 4 in. deep. If replacing a pre-existing 5 in. deep short or medium scanner, these screws will bring the platter up to the countertop level.</li> <li>▶ Allows fine adjustment of short and medium model MP6000/MP7000 scanners so they are perfectly flush in the checkstand, while matching the 12.5cm / 5" depth of some older laser bioptic scanners</li> <li>▶ Extended length screws which will protrude 1"-inch (25 mm) below the bottom of the unit.</li> </ul>	
-------------------	---	--	---	--

**Power Supplies/Power Cords**

Part Number	Picture	Description	Notes	Required Items
CBL-DC-388A1-01		DC Power Cord for MP7000	<ul style="list-style-type: none"> <li>▶ Used along with Power Supply PWR-BGA12V50W0WW to power MP7000. Can also be used with MP6000, but CBL-DC-375A1-01 is the preferred cable for MP6000.</li> <li>▶ Cable length is 1.8 meters</li> </ul>	
CBL-DC-375A1-01		DC Power Cord for MP6000	<ul style="list-style-type: none"> <li>▶ Used along with Power Supply PWR-BGA12V50W0WW to power MP6000.</li> <li>▶ Cable length is 1.5 meters</li> </ul>	
PWR-BGA12V50W0WW		Power Supply	<ul style="list-style-type: none"> <li>▶ 100-240 VAC, 12V, 4.16A, 50W</li> <li>▶ Provides US DOE Level VI compliance for power efficiency.</li> <li>▶ Replaces PWRS-14000-148R</li> </ul>	<ul style="list-style-type: none"> <li>▶ DC Line Cord (CBL-DC-375A1-01) for MP6000 or DC Line Cord (CBL-DC-388A1-01) for MP7000</li> <li>▶ AC Line Cord (23844-00-00R)</li> </ul>
KIT-PWR-12V50W		Power Supply Kit for MP7000	<ul style="list-style-type: none"> <li>▶ Includes Power Supply (PWR-BGA12V50W0WW) and DC Line Cord (CBL-DC-388A1-01)</li> <li>▶ Used to power MP7000. Can also be used with MP6000, but CBL-DC-375A1-01 and BGA12V50W0WW is the preferred cable and power supply for MP6000.</li> </ul>	AC Line Cord (23844-00-00R)
23844-00-00R		AC Line Cord	<ul style="list-style-type: none"> <li>▶ This AC Line Cord is for use in North America. See the <b>AC Line Cords by Country</b> TAG for comparable line cords to use in other countries.</li> </ul>	



Zapraszamy do kontaktu!

Więcej informacji: [www.kreski.pl](http://www.kreski.pl)